

Services



Delivering the world

www.jpgl.com

Part of the Jersey Post Group, JPGL offers a complete range of international postal, cross-border logistics and eCommerce services to clients worldwide.

These services are built on over 50 years' experience and enable us to successfully build and tailor bespoke services for a range of international customers.

Delivering the world

www.jpogl.com



Domestic Freight

JPGL provides a full range of logistics services throughout the UK. Our modern fleet of vehicles, trained drivers and knowledgeable, experienced management team provide us with the flexibility to offer our customers a comprehensive range of solutions that meet all commercial or personal transportation demands.



Services to suit you

We offer premium freight services and convenient fulfilment solutions for goods being transported within the UK. We can cater for any shipment size for either same-day or next-day delivery on dedicated, groupage, full-load, or overnight services.

Specialist transport

With our extensive infrastructure and industry experts, we are able to offer bespoke solutions to meet all of your logistics stipulations, including high security, exhibition and out-of-gauge transportation.

Domestic and global network partner services

Whether you are shipping domestically or across international borders, we will ensure that your shipments arrive safely and within the agreed delivery timescales. We pride ourselves on our customer service and, through our global network of trusted partners and approved carriers, we can provide real-time updates on consignment progress and location at any point in its journey.

Specialists in

- Heavy loads
- Bio-pharm goods
- Refrigerated goods
- Hazardous goods
- Express services
- Groupage
- Overnight pallet service
- Abnormal or ad-hoc loads
- Warehousing and storage
- Packaging and crating
- Daily consolidations
- FBA – fulfilment by Amazon



Delivering the world
www.jpgl.com

European Road Logistics

With a large fleet of vehicles ranging in size and capacity, JPGL operates export and import services throughout Europe.



Full loads

JPGL operates export and import full load services throughout Europe and Scandinavia, as well as into the Baltic region. We also offer intra-European movements.

Express

We have a wide range of express vehicles tailored to meet your specifications, ranging from Sprinter vans, 7.5 tonne, 18 tonne, double-manned and full loads. If express delivery is what you require, you can rest assured that we have the resources and experience to get your freight to its destination fast.

Groupage/part loads

Save money where your consignment is less than a container load (LCL) via our groupage services. We will work with different companies to consolidate multiple consignments to make best use, and best value, of available container space.

Our regular departures to France, Belgium, Holland, Germany and Italy give us flexibility to cater for all of your export/import groupage requirements.

We also offer groupage services throughout the rest of Europe and Scandinavia working with our extensive and reliable network of long-standing partners.

Specialists in

- Groupage
- Full/part load haulage and distribution
- Overnight pallet service
- Hazardous freight
- Abnormal/ad-hoc loads
- Customs brokerage
- Warehousing and Storage
- T1 and T2 transit guarantee
- EU fiscal representation



Delivering the world
www.jpgl.com

International Air Freight

Security, customer service and reliability are crucial for successful air cargo services, and we keep these qualities at the core of our air freight solutions.



A personal, tailored service

Our experienced logistics specialists work closely with you to build the correct, tailor-made solution for your needs. The key to our success is proactive communication with a personal, attentive touch. Our specialists will walk you through the entire process, keeping you involved and informed.

Global forwarding - pan-global logistics by land, air and sea.

We provide a full-range logistics services across the UK and internationally.

Whether it's an air freight shipment to go to New York, a sea freight shipment from Shanghai or an urgent box to deliver to Paris, contact our friendly and experienced team who will help you find the perfect solution.

Specialists in

- Heavy loads
- T1 and T2 transit guarantee
- Bio-pharm goods
- Refrigerated goods
- Hazardous goods
- Express services
- Groupage
- Aerospace movements
- FBA shipments
- Customs brokerage
- Low value bulk imports
- Warehousing and storage

Sea Freight Services

We transport shipments of all shapes and sizes port-to-port, door-to-door or warehouse-to-warehouse, working with shipping lines to various ports.



Flexible, cost-effective sea freight services

We have well-established relationships with the world's premier shipping lines and largest ocean carriers. This gives us the freedom and flexibility to offer multiple cost-effective service options for both part-container (LCL) and full-container (FCL) movements on a variety of shipping lines. We offer a premium, reliable service by picking and choosing our shipping lines to find the vessel and the sailing time that best meets your needs.

What does our marine transportation involve?

Our transportation can be for shipments of all shapes and sizes and entire project consignments. We include exact shipping documentation, customs clearance, and full project coordination.

We also provide a range of support services, including:

- Port-to-port pick-ups and deliveries
- Groupage and breakbulk goods
- Roll-on/roll-off service
- NVOCC consolidation services
- Door-to-door service for LCL and FCL
- Cartage and inland freight by truck or rail
- Warehousing and storage
- Export packing and crating
- Charters
- Customs brokerage
- Handling of heavy and dangerous goods
- Express and economy options



Delivering the world
www.jpgl.com

Project Forwarding

Experienced in project forwarding since 1991.

We offer coordinated transportation from our clients to project sites within the UK, throughout Europe and worldwide. We offer a fully managed door-to-door tailored solution for all aspects of the shipping and transportation industry.

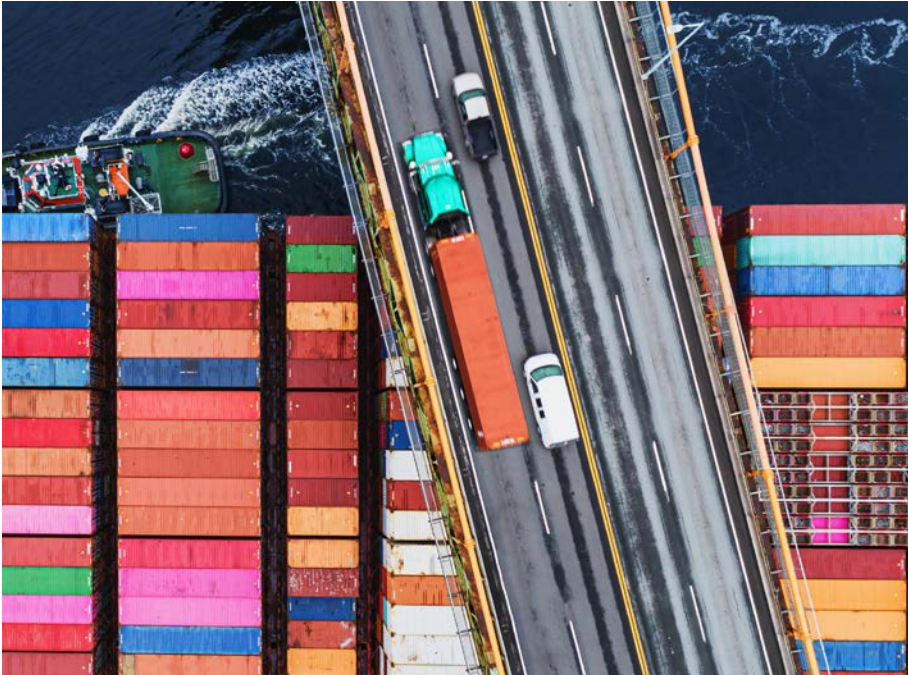

Our vast range of projects include:

- Ship refits
- Exhibition work
- Bespoke out-of-gauge solutions
- Double-manned vehicles

Full project coordination

Our experienced team of project managers work closely with our clients to minimise risk, whilst ensuring we meet project targets in the most cost-efficient way. We interface with the most suitable ship and aircraft owners, freight surveyors, insurance companies and heavy-lift crane companies to ensure the safe handling and stowage throughout transit. All projects are run in accordance with our client's own company policies and procedures.

Pan global logistics by land, air and sea

We offer a full range of logistics services across the UK and internationally. Whether it's an air freight shipment to go to New York, a sea freight shipment from Shanghai or an urgent box to deliver to Paris, our friendly and experienced team will help you find the perfect solution.

Let us manage the entire transport process from beginning to end

- Road and site surveys carried out in advance to determine best routes to ensure performance and safety within budget
- Supervised heavy-lift loading and unloading
- Heavy-lift transportation via land, air and sea
- Assessment of required customs documentation and project certification paperwork
- Compliance with HM Customs, shipping regulations, quality requirements and safety procedures
- Method statement for crane operations and technological inspections
- Status updates communicated with the client throughout the project



Delivering the world
www.jpgl.com

Customs Services



We provide a complete customs brokerage service for courier, air freight, road freight and sea freight imports and exports for customers worldwide. Whether it be time critical, dangerous goods, bio-pharmaceutical or personal effects, airport-to-airport, door-to-door, heavy-weight or consolidation, our team of experts offer an unrivalled service.

AEO accreditation

AEO accreditation is awarded by Her Majesty's Revenue and Customs (HMRC) and is recognised throughout the EU and internationally. It is achieved by businesses that meet strict customs criteria by demonstrating quality, compliance and trustworthiness in the international supply chain.



Customs-cleared end-to-end eCommerce and logistics solutions

With over 100 years' experience and expertise within the industry, let us take the pain out of the process, by providing you with a seamless end-to-end customs-cleared delivery solution.

Specialists in:

T1 and T2 transit guarantee

JPGL is a "known consignor" which allows us to issue simplified T1 movement documents, meaning the haulier can go directly to the port of destination without delays. For anyone shipping goods from the UK to the EU, let us simplify the process by managing the submission of your T1 and T2 transit declarations.

eCommerce clearance

The clearance of eCommerce shipments through our Bulk Import Reduced Data Set (BIRDS), formally known as LVBI procedures, is an integral part of our daily business. Whether the shipments are of low-value, mid-value or high-value, we have the knowledge and experience to customs clear and deliver these consignments.

FBA – Fulfilment by Amazon

The clearance of FBA shipments is part of our daily business and, once cleared, can be delivered into the Amazon facilities.



Delivering the world
www.jpgl.com

Warehousing, Storage and Fulfilment Services

Warehousing and storage

Our extensive warehousing space of 120,000ft² over three locations is reinforced by rigorous safety precautions to ensure the constant security of your products.

In addition to significant secure storage capacity, our warehouse sites offer:

- Customs bonded warehousing
- Narrow aisle racking to maximise space utilisation
- Abnormal sized storage
- Pallet provision, palletisation, shrink and stretch wrapping
- National distribution via overnight pallet network
- Express deliveries via dedicated vehicles
- Handling of heavy and dangerous goods
- Worldwide shipping by air, land and sea

Domestic and worldwide fulfilment and logistics solutions

Our experienced team work with each customer's requirements to build a suitable eCommerce solution. As well as warehousing, storage and pick and pack fulfilment services, we can offer a full range of domestic and cross-border collection and delivery services.



Logistics and fulfilment

We offer a range of flexible and reliable fulfilment and pick and pack services, including picking, packing and storage, through to invoicing and despatch. We can receive, handle, manage and store your products in our secure warehousing, and then package and ship orders based on your instruction.

Extensive distribution network

Once all orders are picked, they will be packed into bespoke packaging for shipment to their end destination. We have access to an extensive global network and a range of supply chain partners, meaning we can provide a much wider choice of onward services and options to our client base.

The range of Pick and Pack services we offer includes:

- Re-packing and re-boxing
- Product re-work
- Consolidation, labelling and re-labelling
- Fulfilment
- Distribution within the UK and worldwide via global parcel distribution networks
- FBA Shipments

Looking to send large letter volumes internationally? LetterMax offers three convenient and flexible services for the mailing of light documents, brochures and letters up to 2kg, including economy, untracked, tracked, proof-of-delivery and compensation options.

Delivery services



Economy

A simple low-cost, international letter mail solution to reach your customers around the world.



Value

Offers a reliable, yet timely and cost-effective, untracked worldwide letter service.



Premium

Provides end-to-end tracking with proof of delivery where offered and optional compensation.

This service is designed for mailings of letters or documents in any of the following formats up to 2kg in weight.

Letter

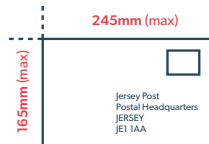

 Up to **100g** |  Thickness **5mm (max)**

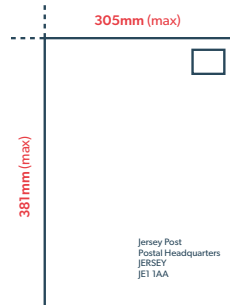

Large Letter

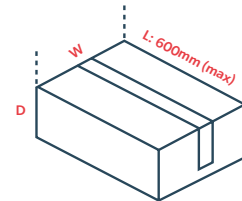

 Up to **500g** |  Thickness **20mm (max)**

Parcel



 Combined **L + W + D** |  Up to **900mm** |  Up to **2kg**

No goods or merchandise may be sent using the LetterMax service, only documents. For the posting of goods and merchandise, please see our ParcelMax services.

For all your bulk mailing needs

Through our extensive global network of established commercial and postal routes, we offer a range of worldwide letter and parcel delivery services tailored to suit your needs. Whether you need a comprehensive, fast, fully-tracked service or a simple economy service, talk to us to discuss your requirements.

ParcelMax offers a range of convenient and flexible international delivery services for parcels up to 30kg; including untracked, tracked, proof-of-delivery and compensation options.

Delivery services



Economy-Lite

A simple solution for lightweight, up to 2kg parcels, enabling you to reach customers worldwide with a reliable, cost-effective service.



Value

A cost-effective logistics solution for eCommerce traffic of all sizes. Tracking and proof-of-delivery where available in the destination country.



Premium

A comprehensive service with end-to-end tracking, proof-of-delivery and optional compensation, available for eCommerce items both small and large.

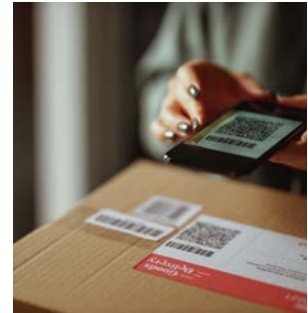

Bespoke solutions

Through our extensive global network of established commercial and postal routes, we offer a range of worldwide delivery services tailored to suit your needs.

This service is designed to ship parcels up to 30kg in one of the following formats.

Parcel

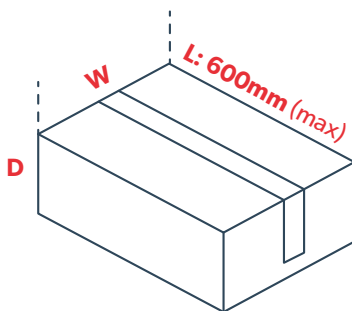

	Up to 2kg	Combined L + W + D	Up to 900mm
---	-----------	--------------------	-------------

Large Parcel

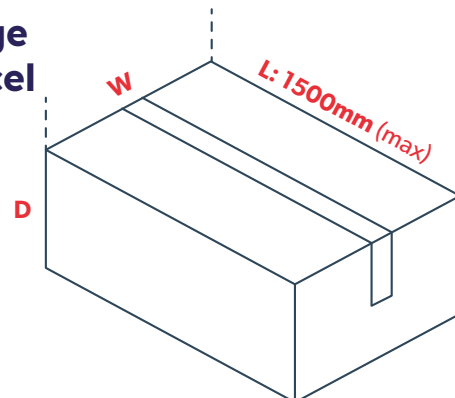

	Up to 30kg	Combined L + W + D	Up to 3000mm
---	------------	--------------------	--------------

Simple booking of shipments, processing of customs pre-clearance advice and creation of labels through our bespoke shipping tool.





UK to the Channel Islands overseas domestic services



- Jersey
 - Guernsey
 - Sark
 - Alderney
 - Herm
- The Channel Islands are a group of British dependency islands located in the English Channel, just off the coast of France. Combined, the population is over 170,000, giving you the fantastic opportunity to access a brand new eCommerce market.

Shipping to the Channel Islands has never been easier.

Our range of tailor-made overseas domestic delivery services offer everything you expect from a customer-focussed, express service into the Channel Islands.

 <p>Delivery before Noon*</p>	 <p>24 Hour Delivery*</p>	 <p>2 Day Delivery*</p>	 <p>Click + Collect</p>	 <p>Returns Service</p>
---	---	---	--	---

*To Jersey and Guernsey where we offer delivery six days a week. Deliveries to Sark, Alderney and Herm can take up to seven working days.

Integration Partners

We partner with a number of platform providers to make parcel delivery to, and returns from, the Channel Islands significantly easier for eCommerce retailers and the end customer.

The perceived cost and complexity of delivering to the Channel Islands can prevent online retailers from offering services to this market. However, our integrations enable retailers to start shipping to the islands more quickly and easily.



Delivering the world
www.jpgl.com

Talk to us

Talk to JPGL about our network of worldwide distribution routes and our international freight forwarding and logistics services.

Visit **jpgl.com** today.

E: info@jpgl.com
www.jpgl.com

Part of the Jersey Post Group